

Eco 48 Real-time PCR

Operation Manual

PCRmax rev A.4

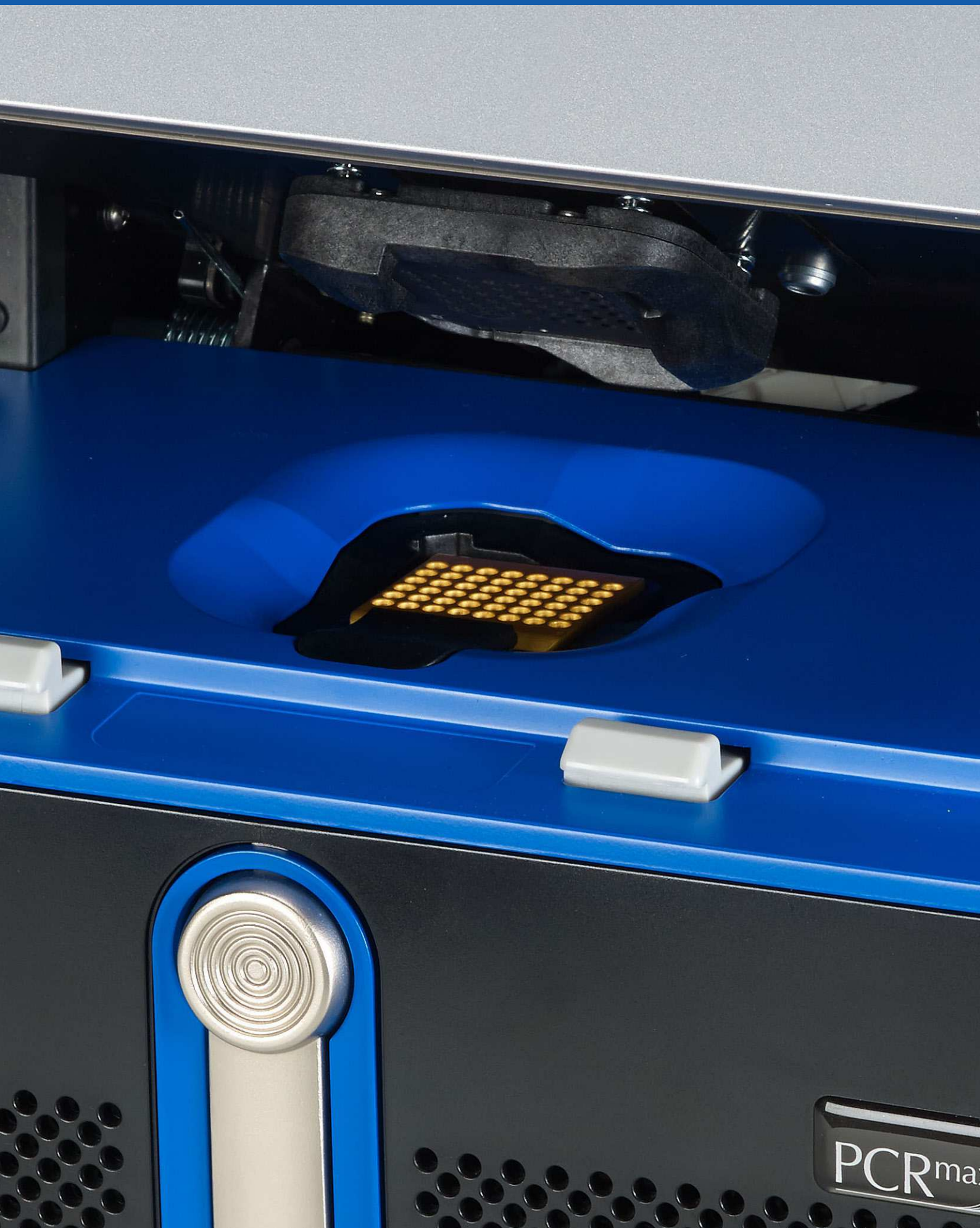

Intended use

INTENDED USE: The Eco 48 Real-Time PCR System is intended to support the Real-Time polymerase chain reaction (PCR) application needs of life science researchers. This includes gene expression quantification and analysis as well as genotyping by allelic discrimination or high- resolution melting. The system is able to support other applications and protocols as well. Eco 48 features high-quality optical and thermal modules to provide optimal performance and data quality. The system includes data analysis software that is preloaded on a computer and provided on a separate USB drive for installation on additional computers as needed. Additional accessories and consumables are provided or available for purchase to ensure the best user experience.

Use of the Eco for specific intended uses, such as polymerase chain reaction (PCR), Real-Time qPCR, or high-resolution melting (HRM) may require the user to obtain rights from third parties. It is solely the user's responsibility to obtain all rights necessary for the intended use of Eco 48.

This document and its contents are proprietary to PCRmax and its affiliates, and are intended solely for the contractual use of its customer in connection with the use of the product(s) described herein and for no other purpose. This document and its contents shall not be used or distributed for any other purpose and/or otherwise communicated, disclosed, or reproduced in any way whatsoever without the prior written consent of PCRmax. PCRmax does not convey any license under its patent, trademark, copyright, or common-law rights nor similar rights of any third parties by this document.

The instructions in this document must be strictly and explicitly followed by qualified and properly trained personnel in order to ensure the proper and safe use of the product(s) described herein. All of the contents of this document must be fully read and understood prior to using such product(s).

FAILURE TO COMPLETELY READ AND EXPLICITLY FOLLOW ALL OF THE INSTRUCTIONS CONTAINED HEREIN MAY RESULT IN DAMAGE TO THE PRODUCT(S), INJURY TO PERSONS, INCLUDING TO USERS OR OTHERS, AND DAMAGE TO OTHER PROPERTY.

PCRMAX DOES NOT ASSUME ANY LIABILITY ARISING OUT OF THE IMPROPER USE OF THE PRODUCT(S) DESCRIBED HEREIN (INCLUDING PARTS THEREOF OR SOFTWARE) OR ANY USE OF SUCH PRODUCT(S) OUTSIDE THE SCOPE OF THE EXPRESS WRITTEN LICENSES OR PERMISSIONS GRANTED BY PCRMAX IN CONNECTION WITH CUSTOMER'S ACQUISITION OF SUCH PRODUCT(S).

FOR RESEARCH USE ONLY

PCRmax rev A.4

© 2010-2014 PCRmax, Inc. All rights reserved.



Contents

	Page
Revision History	2
Table of Contents	3
Chapter 1 Overview	5
Real-Time PCR	5
Absolute and Relative Quantification	6
Genotyping and High Resolution Melt	7
Multiplexing Real-Time PCR	8
Chapter 2 Setup	9
Unpack the Eco 48	9
Place Eco 48 on the Bench	9
Connect Eco 48	9
Turn on the Eco 48	10
PC Setup	11
Register your Eco 48	11
Chapter 3 Workflow	12
Eco 48 Workflow	12
Load the Plate	12
Define a New Experiment	13
New session tab	14
Set Up the Thermal Profile	14
Define the Plate Layout	15
Assays and reporter dyes	15
Assays and reporter dyes for genotyping	16
Set up assays	16
Set up samples	18
Assign assays and samples to wells	19
Define standards	20
Auto-calculate serial dilutions	20
Manually enter dilutions	20
Assign dilutions automatically	20
Assign dilutions manually	21
Monitor Run	21
Export Results and Data	22
Templates and Sample Sheets	23
Making a Sample Sheet for Import	24
Chapter 4 System Information	25
Components	25
System Requirements	27

Contents (Continued)

Specifications and Environmental Requirements	27
	Page
Symbols	28
Electromagnetic Compatibility	29
Cleaning And Maintenance	29
Chapter 5 Troubleshooting	30
Introduction	30
Run Recovery	30
Power cycling	30
Recover last experiment	31
Accessing Log Files	31
Identifying Serial and Version Numbers	31
Appendix A Concepts and Glossary	32
Concepts	32
Glossary	33
Technical Assistance	36
Declaration of conformity	37

© The copyright of this instruction book is the property of PCRmax (A Bibby Scientific Company). This instruction book is supplied by PCRmax (A Bibby Scientific Company) on the express understanding that it is to be used solely for the purpose for which it is supplied. It may not be copied, used or disclosed to others in whole or part for any purpose except as authorised in writing by PCRmax (A Bibby Scientific Company). PCRmax (A Bibby Scientific Company) reserves the right to alter, change or modify this document without prior notification. In the interest of continued development PCRmax (A Bibby Scientific Company) reserve the right to alter or modify the design and/or assembly process of their products without prior notification.

PCRmax Limited

Beacon Road,
Stone,
Staffordshire
ST15 0SA,
United Kingdom
Tel: +44(0)1785 812121
Fax: +44(0)1785 810405
e-mail: enquiries@pcrmax.com
www.pcrmax.com

Real-Time PCR

Polymerase Chain Reaction (PCR) denotes the amplification of DNA templates catalyzed by DNA polymerase in the presence of primers, dNTPs, divalent cations (like Mg^{+2}), and a buffer solution. The ability to visualize and quantify the amplification of DNA as it occurs during PCR is called Real-Time PCR or Quantitative PCR (qPCR). This is made possible by the use of fluorescent chemistries, an optical system that can capture the emitted fluorescence at every PCR cycle, and software that can quantify the amplification.

The two most commonly used qPCR chemistries are DNA binding dyes and hydrolysis probes (Figure 1). DNA binding dyes fluoresce when bound to double-stranded DNA. Hydrolysis probes fluoresce when the reporter molecule is removed from its quencher molecule by the 5' exonuclease activity of DNA polymerase.

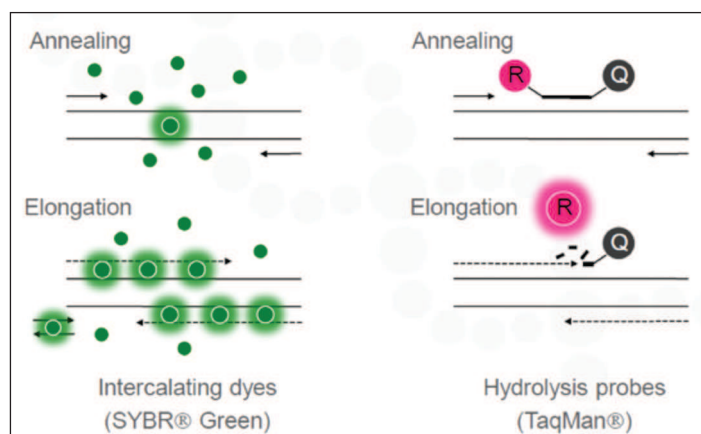

Figure 1 Main Real-Time PCR Chemistries

Little fluorescence is generated during initial PCR cycles (Figure 2). Data from these early cycles define the baseline for the assay (Initial). As fluorescence approaches the level of optical detection, the reaction reaches the exponential phase, which is the region where the C_q is determined. C_q is the PCR cycle at which the fluorescent signal crosses the detection threshold level and is used for quantification. Finally, as reaction components are consumed and amplicons become abundant, the generation of additional fluorescent signal slows down and eventually reaches a reaction plateau.

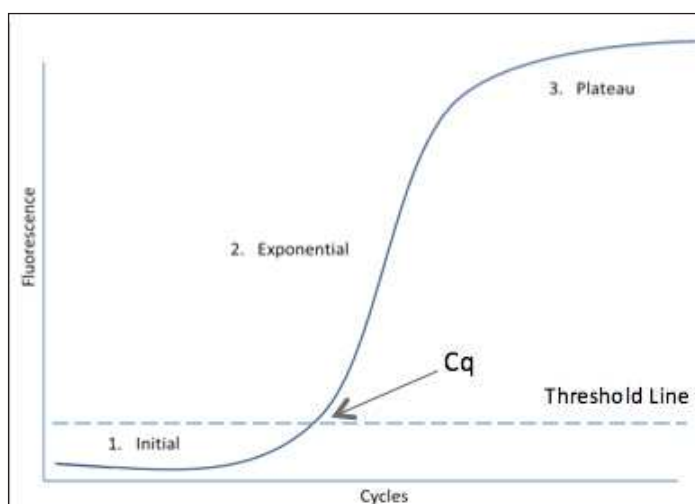

Figure 2 The Three Phases of qPCR

Resources

Saiki RK, Scharf S, Faloona F, Mullis KB, Horn GT, Erlich HA, Arnheim N (1985) *Science* 230: 1350–1354
 Higuchi R, Fockler G, Dollinger G, and Watson R (1993) *Biotechnology (N.Y.)* 11: 1026–1030

Absolute and Relative Quantification

The two primary methods used to quantify nucleic acids by qPCR are the absolute and relative quantification methods.

The absolute quantification method is based on a standard curve generated from serial dilution of a nucleic acid template of known concentration (Figure 3). Quantification of unknown samples is determined by interpolating the sample C_q from the standard curve. (Throughout the rest of this document, absolute quantification is referred to as a standard curve experiment.)

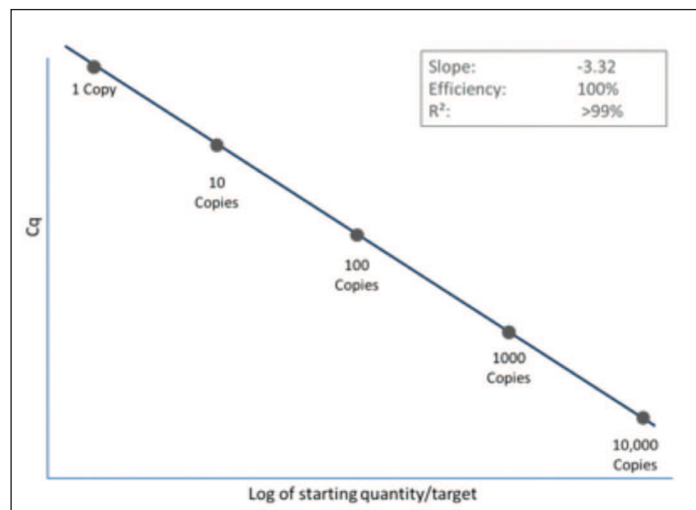

Figure 3 Five-Point (10-Fold) Standard Curve

The slope of the standard curve measures the efficiency of the assay ($E = 10^{(-1/\text{slope})} - 1$). A slope outside the acceptable range (slope -3.1 to -3.6 and E value between 90 and 110%) typically indicates a problem with the template or assay design. The R^2 value, a measure of reaction performance, should be > 0.99 for the assay to accurately quantify unknown samples.

The relative quantification method measures the level of gene expression in a sample relative to the level of expression of the same gene in a reference sample. In addition, the level of expression of every gene in the assay is normalized to the expression of a reference gene.

The results (RQ value) obtained are expressed as relative levels (or fold change) in gene expression compared to the reference or control sample (Figure 4).

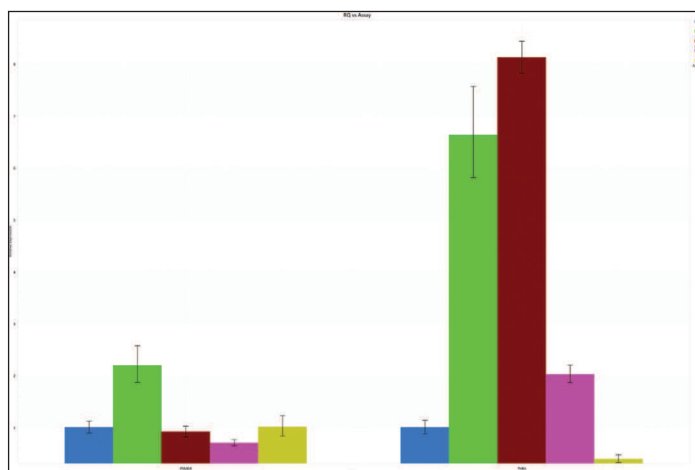

Figure 4 Relative Quantification Experiment

Genotyping and High Resolution Melt

Genotyping (allelic discrimination) assays using hydrolysis probes provide a rapid and sensitive method to genotype samples. These assays can refer to a single nucleotide polymorphism (SNP) or insertion/deletion assays. Two variants/alleles are interrogated at the same time (multiplex qPCR). Most frequently, one probe is labeled with a FAM dye and the other with a VIC dye. Samples with FAM signal and no VIC signal are homozygous for allele 1; samples with VIC signal and no FAM signal are homozygous for allele 2; and samples with both FAM and VIC signal are heterozygous (Figure 5).

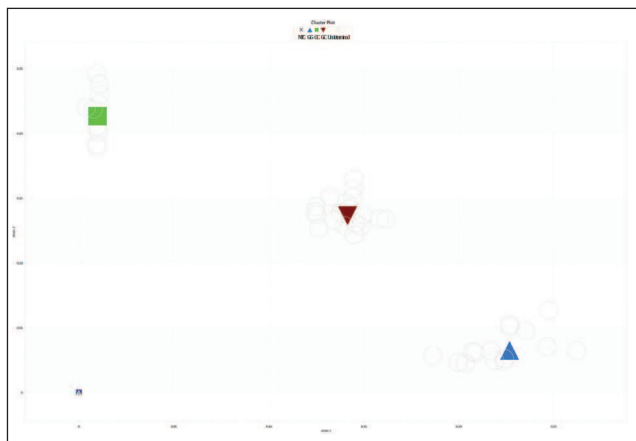

Figure 5 Allelic Distribution Scatter Plot

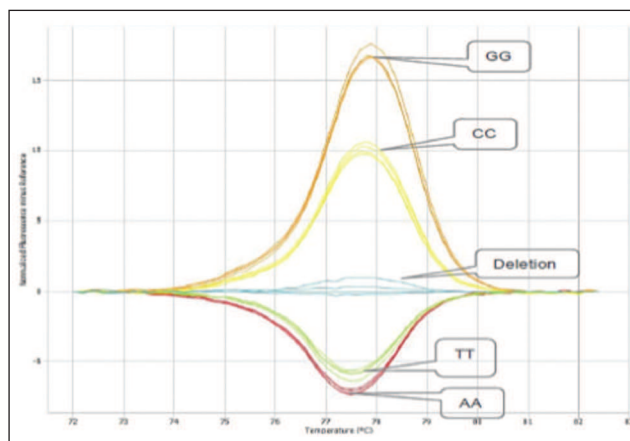

Figure 6 HRM Difference Plot

High Resolution Melt (HRM) enables the detection of almost any genetic variation (SNPs, mutations). Because HRM assays only require primers and a dye (no probes or DNA sequencing), the method is simpler and cheaper than traditional genotyping approaches. After the amplification phase, the amplicon is slowly heated until it melts. The melting temperature and profile are directly linked to the amplicon sequence.

HRM's power comes from the resolution of the sample's melt profile. It requires a high-quality optical system and precise thermal uniformity. HRM PCR amplicons below 300 bp provide the best resolution. The shape of the resulting melting curves, which is sensitive to almost any genetic change, determines sample identity. To easily cluster equivalent samples, a reference curve (e.g. Wild Type) is subtracted from the other curves to generate a difference plot (Figure 6). Captions added to illustrate the different genotypes only.

Resources

Livak KJ (1999) Allelic discrimination using fluorogenic probes and the 5' nuclease assay. *Genet Anal Biomol Eng* 14: 143–149

POLAND server (<http://www.biophys.uni-duesseldorf.de/local/POLAND/poland.html>) Wojdacz TK, Dobrovic A, Hansen LL (2008) Methylation-sensitive high-resolution melting.

Nature Protocols 3(12): 1903–1908

Multiplexing Real-Time PCR

The simultaneous detection of multiple targets in a single reaction is called multiplexing. An advantage of multiplexing is that it conserves sample, allowing more data to be obtained from the same amount of material. Another advantage is that multiplexing permits the inclusion of an internal control reference assay for normalization purposes, significantly increasing data precision.

Channel	Dye
Channel 1 ($\lambda = 505\text{-}545\text{ nm}$)	SYBR Green™, FAM™
Channel 2 ($\lambda = 604\text{-}644\text{ nm}$)	ROX™, Texas Red
Channel 3 ($\lambda = 562\text{-}596\text{ nm}$)	HEX™, JOE, TET, VIC™
Channel 4 ($\lambda = 665\text{-}705\text{ nm}$)	Cy®5, Q670™

Table 1 Examples of Eco 48-Compatible Dyes

Validating a multiplex qPCR assay can be challenging. The advent of more advanced qPCR master mixes has significantly reduced the amount of optimization typically required, making multiplex qPCR a much more attractive alternative. Validation of assays using a standard curve is a must to ensure data accuracy.

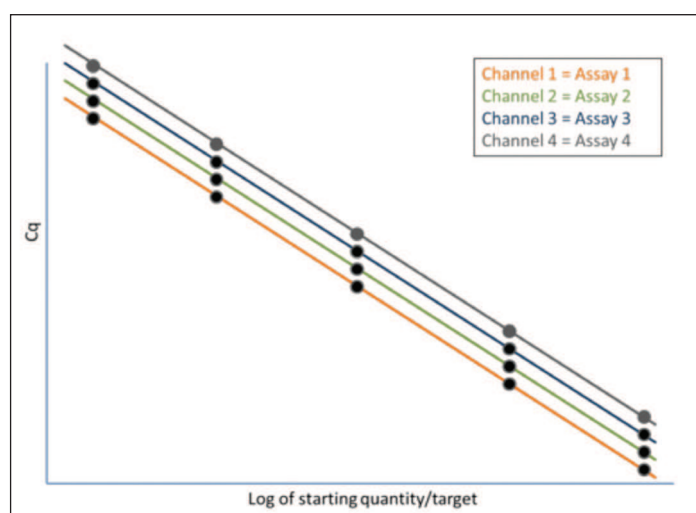

Figure 7 Standard Curves for Four Multiplexed Assays

The Eco 48 includes two excitation LED arrays (452-486 nm and 542-582 nm) and four filter channels (Table 1), which enable detection of up to four separate targets in a single reaction (Figure 7).

Eco 48 is factory-calibrated for certain dyes within each channel (marked in Table 1), but also supports additional dyes that are excited and detected within the instrument specifications

2. Setup

2.1. UNPACK THE Eco 48

- 1 Remove the computer and accessories from the box.
- 2 Lift the Eco 48 instrument out of the crate. Place it on a flat surface and remove the foam packaging.
NOTE Keep the box and packaging in case of a return.
- 3 Check to ensure that all components are present and intact.

Your system comes with:



2.2. PLACE Eco 48 ON THE BENCH

Eco 48 requires 5 cm (2 inches) of unimpeded space at the front and back for ventilation and 7.5 cm (3 inches) above the instrument so that the lid can be opened safely. Make sure you have easy access to the power switch on the lower right back corner of the Eco 48 instrument and that there are two wall outlets (100-240 VAC, 50-60 Hz, 5A) within 2 m (6 feet) of the instrument.

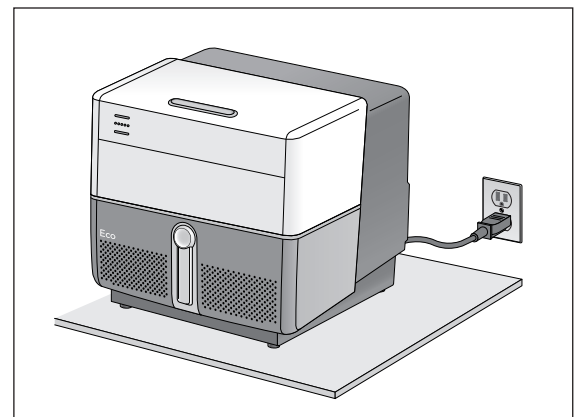

Figure 8 Eco 48 Space requirements

2.3. CONNECT Eco 48

- 1 Connect one end of the Ethernet cable to the Ethernet port on the computer. Connect the other end to the Ethernet port on the rear panel of the Eco 48 (A). Equipment must be connected to reliable and suitable protective earth connection
- 2 Connect the Eco 48 power cord to the AC power inlet on the rear panel, and then to the wall outlet (B). A suitably approved mains power cord set may be used. It must be ensured that the cord set meets the host country requirements.
- 3 Connect the computer power cord to the wall outlet (C).

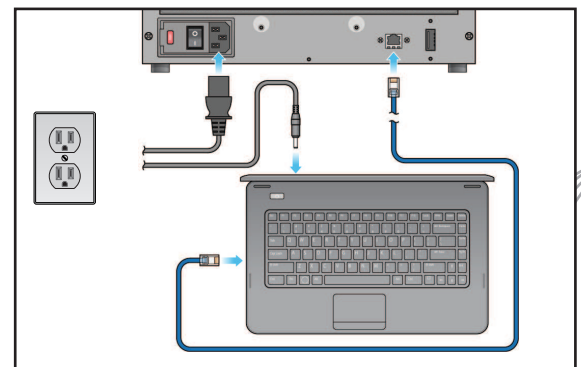

Figure 9 Eco 48 Connection

Setup

2.4. TURN ON THE Eco 48

- 1 Turn on the computer, wait up to five minutes for Microsoft Windows to boot fully, then turn on the Eco 48 instrument (A). The instrument runs a series of self-tests that take up to 20 minutes.
- 2 At any time after turning on the instrument, double-click the Eco 48 icon on the computer desktop to start the Eco 48 software (B). Communication between the computer and the Eco 48 instrument is established within five minutes. When the READY indicator lights on the front panel stop flashing and remain solid, the instrument is ready.
- 3 Open the Eco 48 by pressing the round silver button on the front to raise its handle, while lifting the handle from the bottom until the Eco 48 pops open (C).



Figure 10 Eco 48 Startup Sequence

2.5. PC SETUP

The Eco 48 system's controlling PC must be set up to ensure that there is constant communication between the system and the PC. To that end we need to alter the default power settings, network setting and firewall. The PC controlling the Eco 48 should be a designated stand alone unit.

Minimum PC Specification

- Operating system: Windows 7, not starter, and in UK or USA English. Either 32 or 64 bit variants are compatible.
- Memory (RAM): 4GB DDR3
- Communication: Gigabit Ethernet and USB 2.0
- Processor: Core i3 (3rd generation) with 1.7 GHz clock speed or greater.

PC Power Settings

Purpose – To prevent the PC from shutting down during a run as it sees no user interaction.

- Open the Control Panel from the Windows Start menu.
- Open "Power options", double click to open and change battery or power settings.
- Navigate to "Change plan settings".
- In "Edit plan settings" change all of the power options to "Never". Save the changes to the plan

Firewall Settings

Purpose – To allow data communication with Eco48

- Open the Control Panel and select "Windows Firewall"
- Select "Check Firewall Status",
- If the firewall is "on" click "Turn Windows Firewall On or Off" Turn off the firewall.
- In the "Windows Firewall" page, the status should now read "Off"

Network Port Settings

Purpose – Prevents the PC from turning off the network port and losing communication with Eco48.

- Open Control Panel and select "Network and Internet" sometimes called "Network and Sharing".
- Open "Local Area Connection" and select "Properties" then "Configure"
- Select "Power Management" and uncheck "Allow the computer to turn off this device to save power".
- Click "OK" and exit.

2.6. REGISTER YOUR Eco 48

Once your Eco 48 system is set up and ready to use, register your Eco by going to www.pcrmax.com and completing a short questionnaire. Registering your Eco ensures that you will receive software updates in the future. While you are visiting the web site, take advantage of the following online resources to support your research.

Eco Customer Support, knowledge database, warranty information, webinars, and seminar series
www.pcrmax.com

Online Ordering www.pcrmax.com

Tradeshows, workshops, and meeting presence www.pcrmax.com or contact your local dealer

3. Workflow

3.1. Eco 48 WORKFLOW

- 1 Prepare the sample plate, load it into the Eco 48, and close the lid. See Load the Plate on page 12.
- 2 Launch the Eco 48 software on the PC.
- 3 Define and name the experiment by selecting the application, detection chemistry, starting material, and specific method for your application. See Define a New Experiment on page 13.

TIP To use a pre-defined thermal profile and plate layout for your experiment, click [Templates](#) and select one of the template experiments saved on your computer.

- 4 Review the thermal profile and adapt it if needed. See Set Up the Thermal Profile on page 14.
- 5 Set up the plate layout by defining assays, samples, and standards and assigning them to wells. See Define the Plate Layout on page 15.
- 6 Start the run. The Monitor Run tab opens. See Monitor Run on page 21.

WARNING Do not open the lid while a run is in progress. This allows extraneous light into the system and will corrupt the data.

- 7 When the run is complete, open the Eco 48 lid. Press the plate release lever and remove the plate from the block. Dispose of any hazardous materials in biohazard, caustic material, or other appropriate containers, according to your local safety regulations.

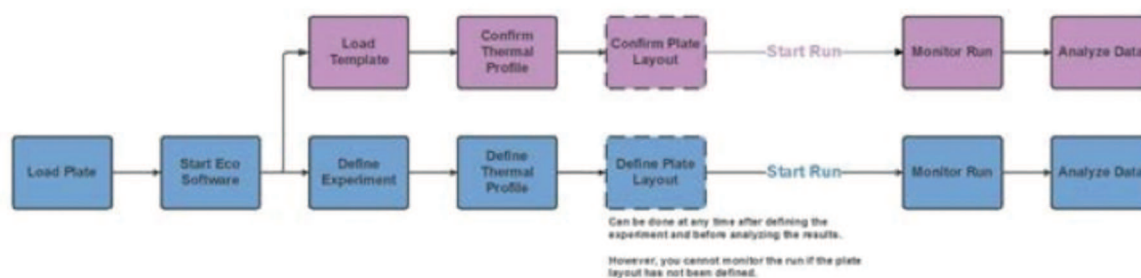

3.2. LOAD THE PLATE

- 1 Thaw all necessary reagents (templates, primers, probes, and master mix).
- 2 Turn on the PC, then the Eco 48, and wait until the Eco 48 Ready light is solid blue.
- 3 Confirm that the block and optical path are clear of visible contaminants and there is no physical damage to the system, such as dents, frayed cords, or damaged levers.
- 4 Place a 48-well plate into the Eco 48 sample loading dock, aligning the notch with the matching indentation on the adapter.
- 5 Turn on the dock light and incline the dock to a comfortable angle for pipetting.
- 6 Pipette samples and qPCR reagents into the plate according to your protocol.

WARNING Wear protective gloves and eyewear when handling any material that might be considered caustic or hazardous.

- 7 Seal the plate with an Eco 48 optical seal. Holding the plate in place on the Eco 48 sample loading dock, drag the squeegee firmly across the surface to ensure the seal is secure.
- 8 Place the plate adapter with your loaded and sealed plate into a compatible centrifuge rotor along with the second supplied plate adapter for balance. Centrifuge the plate at 250 g for 30 seconds. Do not spin more than 500 g. Verify that there are no air bubbles at the bottom of the wells.
- 9 Open the Eco 48 lid and place the plate on the block, aligning the notch against the top-left corner.

WARNING Forcing the plate into any other orientation could damage the instrument.

WARNING Be careful not to touch the heated lid above the plate. It heats to 105°C (221°F) when the instrument is turned on and could result in burns.

- 10 Close the Eco 48 lid. The heated lid automatically creates a seal around and on top of the plate to prevent evaporation.
- 11 Proceed to Define a New Experiment.

3. Workflow

3.3. DEFINE A NEW EXPERIMENT

- 1 Double-click the Eco 48 icon  on the desktop to open the software. The New Experiment tab opens.

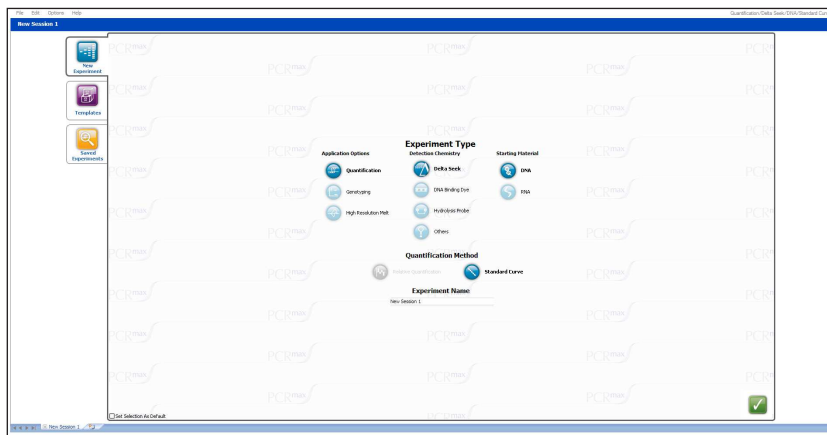

Figure 11 Main Real-Time PCR Chemistries

- 2 Click an Application Option that is the specific method or protocol you want to use for your experiment. When you select the application, the software automatically configures options for downstream setup and analysis. For example, High Resolution Melt (HRM) is associated with DNA Binding dyes and so the other three detection chemistries are grayed out for High Resolution Melt experiments.

Experiment Type	Options
Quantification	Relative Quantification or Standard Curve
Genotyping	Genotyping PCR or Genotyping Single-Read
High Resolution Melt	PCR with HRM Curve or HRM Curve Only

Table 1 Examples of Eco 48-Compatible Dyes

- 3 Select a Detection Chemistry.

Detection Chemistry	Type
DeltaSeek	A probe based qPCR detection system covering: Human pathogen testing kits, Veterinary and agricultural pathogen testing kits, Food and water testing kits and Bio-threat detection kits. For a full list of the over 400 kits available kits go to www.pcrmax.com
DNA Binding Dye	SYBR green assays
Hydrolysis Probe	5' nuclease assays
Other	Non-hydrolytic assays

- 4 Select a Starting Material.
- 5 Enter an experiment name of up to 20 characters.
- 6 Click . The Setup window opens, with the Thermal Profile tab visible.

3. Workflow

3.4. NEW SESSION TAB

Use the New Session tab to create, open, and select multiple experiments. The tab is on the bottom left of the screen. To add a new experiment, select the page with a star icon. You can also right-click on the New Session tab to rename an experiment, make a new experiment, open an experiment, or close an experiment.

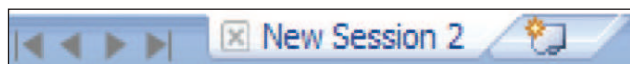
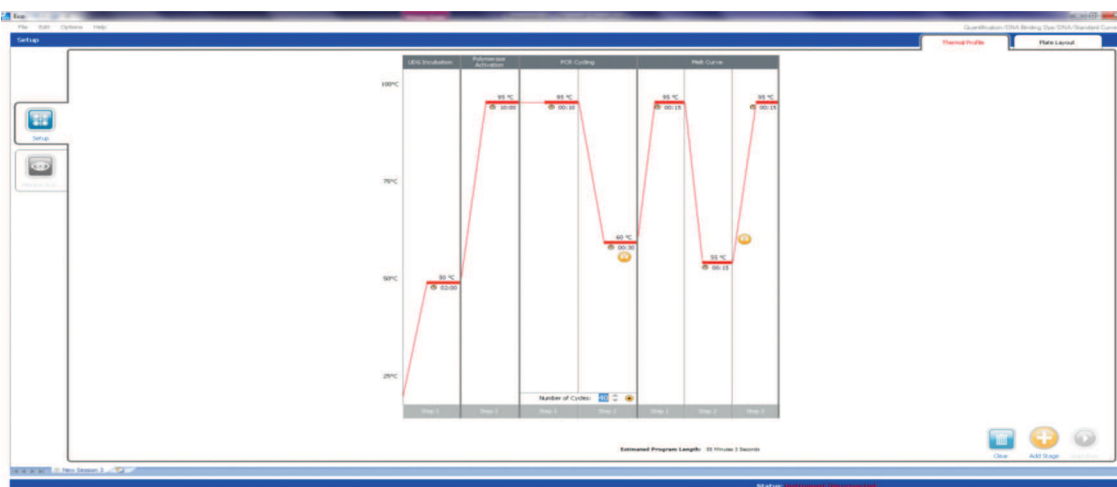



Figure 12 New Session Tab

3.5. SET UP THE THERMAL PROFILE



- A Drag to move the stage
- B Double-click the temperature plateau to adjust temperature and duration
- C Type new temperature
- D Drag the bar up and down to adjust the temperature
- E Data collection point
- F Type new cycle time
- G Toggle two, three, four, or five step PCR
- H Click or type to add or remove cycles

When you define the experiment a corresponding default thermal profile is selected automatically. You can use this or modify it based on your reagent's recommended protocol. You can set up cycle parameters in the Thermal Profile at any time after defining the experiment, but only before starting the run.

Click  to add a new stage, such as a reverse transcription incubation at the beginning or additional PCR Cycling stages. The stage will appear at the end of the cycle and you can drag it to the desired location. Alternatively, you can drag the  icon to the location within the profile where you would like the new stage to be added.

} The camera icon  indicates when the Eco 48 collects image data. In multi-step PCR, you can select whether to collect data at the annealing or extension step. Extension is the default. To move it to annealing, mouse over the annealing step and click the dim camera icon that appears. Only one step can be designated to collect image data.

} To remove a stage, drag it to the  trash can or highlight it and press Delete

3. Workflow

3.6. DEFINE THE PLATE LAYOUT

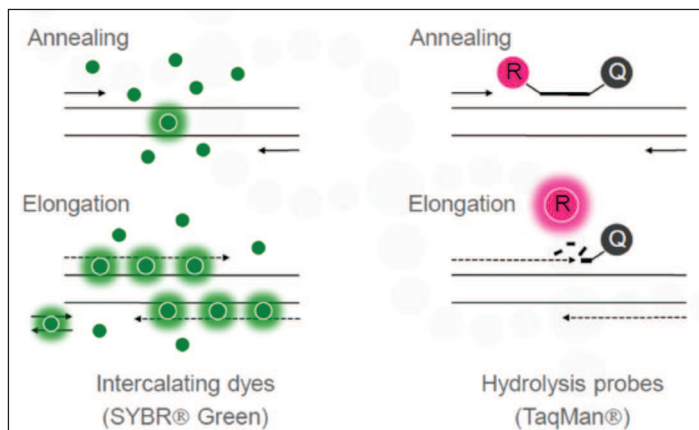

Figure 14 Plate Layout Tab

The Plate Layout tab lets you define how your samples, assays, and standards are laid out on the plate loaded in the Eco 48. The analysis software uses the plate layout to calculate data values. Plate layout involves the following steps:

- 1 Set up assays. See Set Up Assays on page 16.
- 2 Set up samples. See Set Up Samples on page 18.
- 3 Assign assays and samples to wells. See Assign Assays and Samples to Wells on page 19.
- 4 Define standards (Standard Curve Quantification experiments only). See Define Standards on page 20.
- 5 Select the Rox Normalization checkbox if you are using Rox passive reference dye to normalize across your plate.

You can lay out the plate any time between defining the experiment and analyzing the data. However, you will only be able to see deconvoluted data while monitoring the run

3.7. ASSAYS AND REPORTER DYES

An assay is the set of primers or primers/probe used to quantify a nucleic acid target sequence. Assays can have different roles, such as Unknown, Standard, Negative, Positive, or NTC (Non-Template Controls). Each assay is associated with a reporter dye which identifies the assay during analysis. Reporter dyes can belong to one of four “channels”, each of which is defined by a specific excitation and emission range.

You can assign up to four assays per well. Within each well, assays cannot use reporter dyes from the same channel (see following table). If they did, data from assays using the same channel would be indistinguishable during analysis. A red outline around a well indicates that it contains more than one reporter dye from the same channel and requires correction before you can analyze your data.

Table 2 Channels and Reporter Dyes

Channel	Excitation (nm)	Emission (nm)	Fluorophores Calibrated on the Eco 48 (Reporter)
1	452-486	505-545	SYBR® Green I, FAM™
2	542-582	604-644	ROX™
3	452-486	562-596	HEX, VIC™
4	542-582	665-705	Cy®5, Q670™

a. If you use ROX as a passive reference for normalization, your plate layout cannot include an assay whose reporter dye is measured in channel 2.

3. Workflow

3.8. ASSAYS AND REPORTER DYES FOR GENOTYPING

When defining a plate layout, genotyping experiments need special setup of assays and reporter dyes. Assign at least one well for each homozygous Allele 1/Wild Type, homozygous Allele 2/Mutant, and for heterozygous controls. Make sure to select a different reporter dye for each Allele. See Genotyping and High Resolution Melt on page 7.

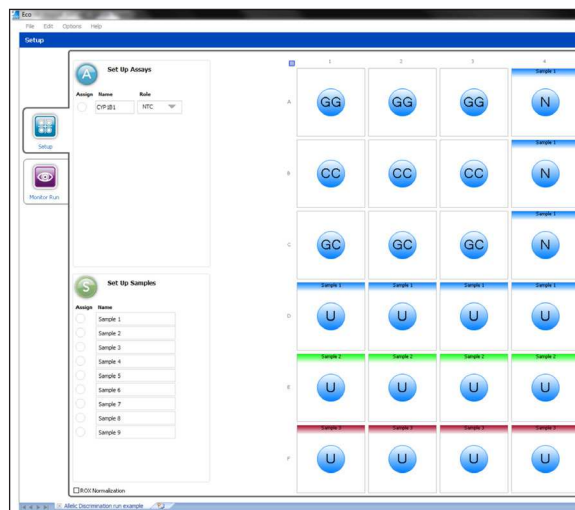

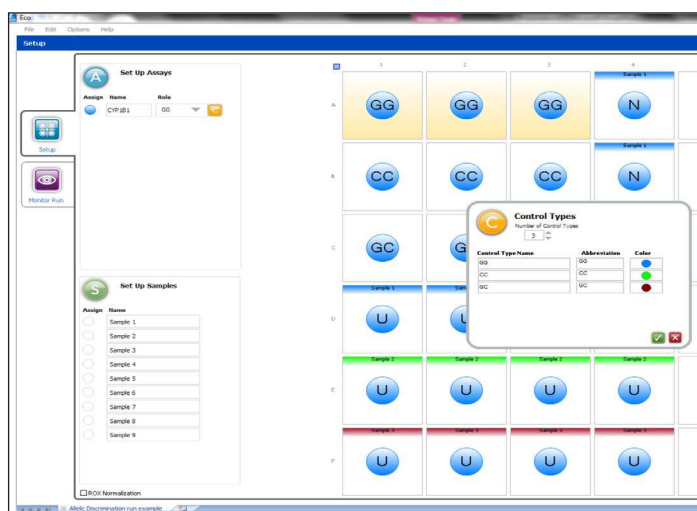

Figure 15 Example Plate Layout for a Genotyping Experiment

3.9. SET UP ASSAYS

- 1 On the Plate Layout tab, click  or Set Up Assays to open the Assays dialog box.
- 2 Use the arrow keys to select the number of assays.
- 3 For each assay:
 - Define a name and color.
 - For Genotyping experiments: Click the yellow box "C" which appears after setting role as Wild Type, Heterozygous or Mutant, this will let you further define the control type name and will automatically define an abbreviation.



- Select a Reporter dye, thereby setting the channel. If your dye is not listed, select a reporter with the most similar excitation and emission range to your dye (refer to the Channel table on Multiplexing Real-Time PCR on page 8).

3. Workflow

For Genotyping experiments: Select a reporter dye for Alleles 1 and 2.

- Select a Quencher. Quencher molecules absorb fluorescent emissions of reporter dyes when in close proximity. By default, the quencher is set to None for DNA binding dye chemistry and Non-fluorescent for Hydrolysis probes.

NOTE BHQ and MGB are considered non-fluorescent quenchers.

NOTE Fluorescent quenchers such as Tamra are not recommended for use in the Eco 48.

For Genotyping experiments: Select a quencher for Alleles 1 and 2.

- For Relative Quantification experiments: Specify the PCR Efficiency (%).

4 Click  to close the Assays dialog box and return to Plate Layout.

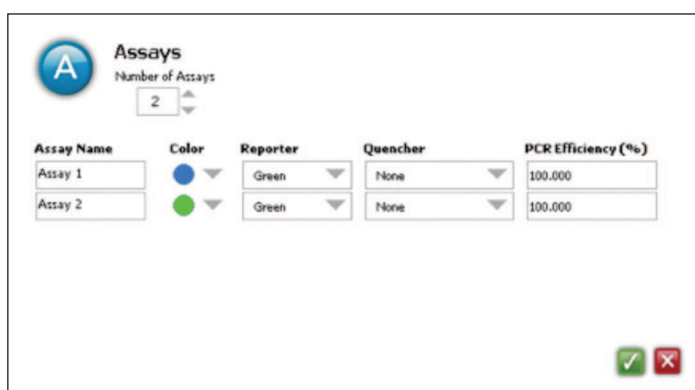



Figure 15 Assay Dialog Box, Relative Quantification Experiments

5 For Relative Quantification experiments: Select at least one Reference assay.

6 For all experiment types: If you want to use controls, select a control type for each assay from the Role drop-down list. Options for roles in the drop-down list change according to the type of experiment.

NOTE The Role you assign has no affect on the analysis calculations of your experiment. The Role is just a label for your convenience. For example, if you want to define an assay as a no reverse transcription control, or you want to define an assay as a control sample that you know to be negative for the target you are amplifying, you can select the Role "Negative" or "NTC". Data from the negative control or NTC is not used in calculations to normalize the data.

7 For Genotyping and High Resolution Melt experiments: If you want controls with unique names that are not included with the software, set them up from the Options menu. After controls are created, they are available for use in the Role drop-down list in the Assays section.

- Click the Options menu.
- Click Control Types.
- Use the arrows to select the Number of Control Types.
- Select the Color. To change the color, select the round color icon next to the assay name. Double-click a new color in the color palette.
- An Abbreviation automatically populates.
- Click OK 

8 Proceed to set up samples

3. Workflow

3.10. SET UP SAMPLES

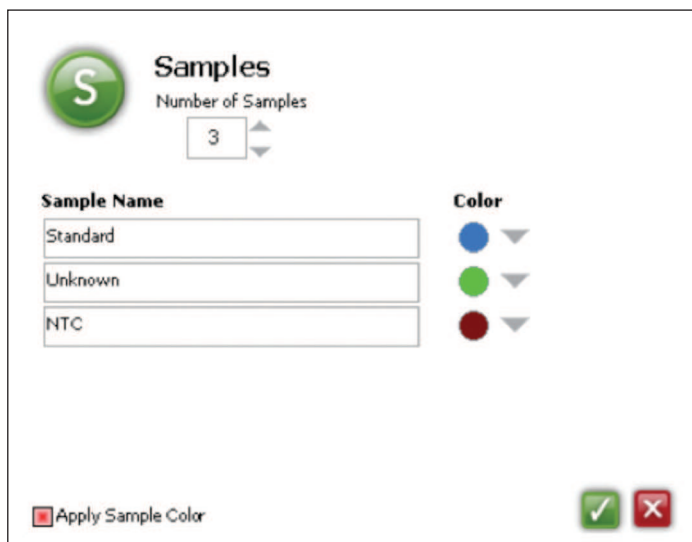



Figure 17 Sample Dialog Box

- 1 On the Plate Layout tab, click  or [Set Up Samples](#) to open the Samples dialog box.
- 2 Use the arrow keys to select the number of samples.
- 3 For each sample, define a name and color.
- 4 Click  to close the Samples dialog box and return to Plate Layout.
- 5 For Relative Quantification and HRM experiments: Select at least one Reference sample.
- 6 Proceed to assign assays and samples to wells.

3. Workflow

3.11. ASSIGN ASSAYS AND SAMPLES TO WELLS



Figure 18 Plate Layout Tab, Assigning Assays and Samples

- 1 Left-click and drag the mouse to highlight one or more wells on the plate layout diagram. Wells turn yellow when they are highlighted, as shown in columns 1 and 2 of Figure 18.
- 2 Click the Assign button for up to four assays and one sample in the left pane of the window to assign the assays and sample to the highlighted wells.
- 3 To change the role of an assay in a given well, highlight the well and then select the desired Assay Role from the drop-down list.

NOTE For quantification experiments that will be combined using the Eco 48 Study software, for at least one plate in the study, you must specify:

- Standard Curve studies: At least two wells with the role "Standard", but with different quantities
- Relative Quantification studies: At least one well with the role "Unknown" or "Positive" and a sample assigned

Any plate meeting these specifications can be used as the mother plate in your study. (The mother plate is the plate against which the other experiments in the study will be compared.)

- 4 For Standard Curve experiments: Proceed to define standards. For other experiments: Click  to start the run now.

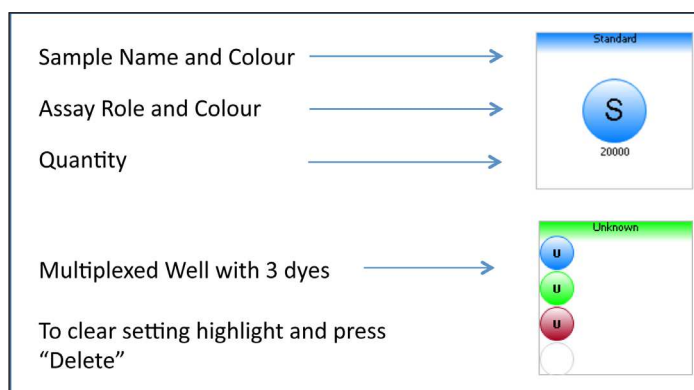
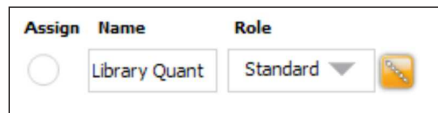



Figure 19 Well in the Plate Layout

3. Workflow

3.12. DEFINE STANDARDS

When you set an Assay Role to Standard, a small orange Standards button appears to the right of the assay role.



- 1 Click  to open the Set Up Standards pane in the lower left of the window.
- 2 Select the units that are used in your standards, and then enter the quantity.

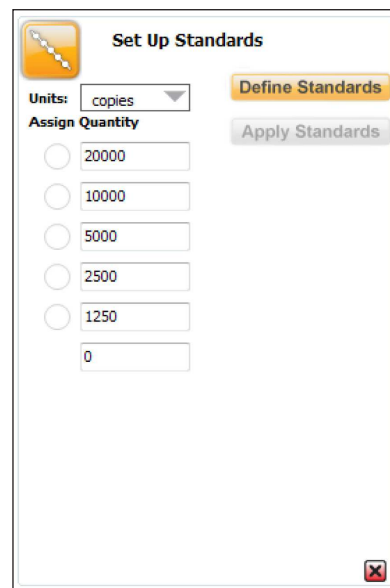
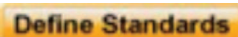



Figure 20 Well in the Plate Layout

3.13. AUTO-CALCULATE SERIAL DILUTIONS

- 1 To auto-calculate serial dilutions, click . The Dilutions dialog box opens.
- 2 Enter the number of points in the standard curve, the quantity of the most concentrated standard, and the desired dilution factor, and then click .



3.14 MANUALLY ENTER DILUTIONS

- 1 Enter the value of the first standard into the first Quantity field below Units.
- 2 Press Enter to commit the value and open the next Quantity field.

3.15 Assign Standard Dilutions to Wells

You can assign standard dilutions to wells manually or automatically.

3.16 ASSIGN DILUTIONS AUTOMATICALLY

- 1 Left-click and drag the mouse over a group of Standard Assay wells.
 - # Vertical Wells = # Points on Standard Curve
 - # Horizontal Wells = # Replicates

The Apply Standards button becomes active when you have selected a suitable group of wells.
- 2 Click . The dilutions and replicates are automatically added in the highlighted group of wells.

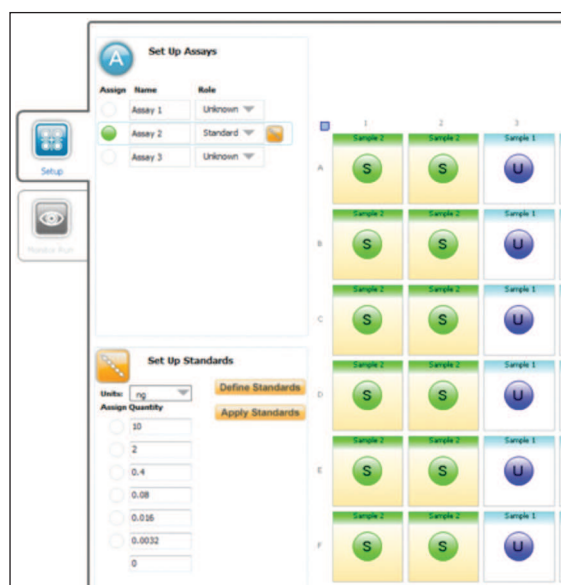

Figure 21 Selecting Standard Assay Wells

3. Workflow

3.17. ASSIGN DILUTIONS MANUALLY

Highlight a Standard Assay well and click the [Assign](#) button beside the appropriate dilution quantity (Figure 22).

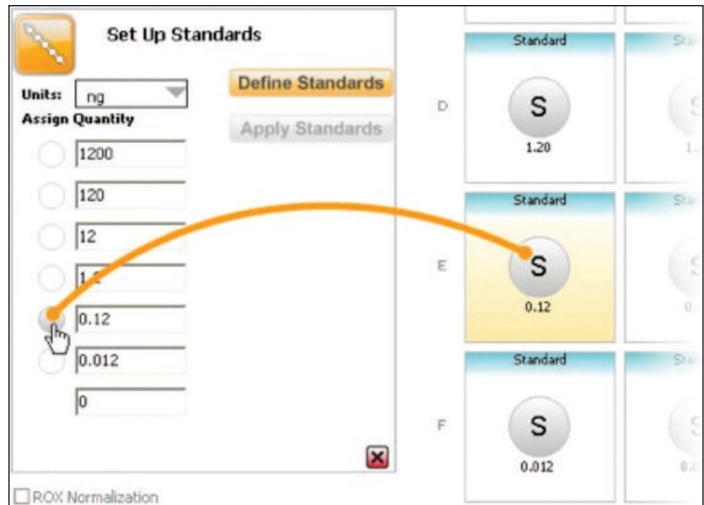

Figure 22 Assigning Dilutions

3.18. MONITOR RUN

WARNING

Do not open the lid while a run is in progress. This allows extraneous light into the system and will corrupt the data.

NOTE

If you have not yet defined the plate layout (Define the Plate Layout on page 15), you will only be able to view progress against the Thermal Profile on this tab.

- A Select assays to view in Amplification Plot
- B Shows current stage of the Thermal Profile highlighted in orange
- C Amplification View shows deconvoluted data in real time for each well
- D Amplification Plot shows deconvoluted data in real time for selected wells

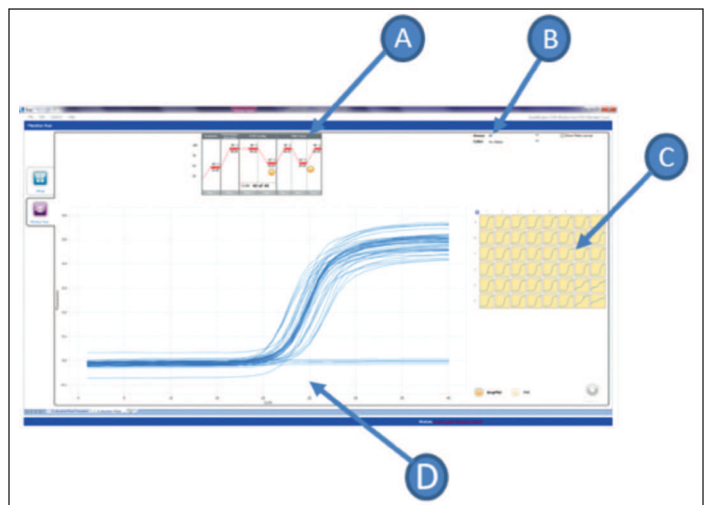

Figure 23 Monitor Tab

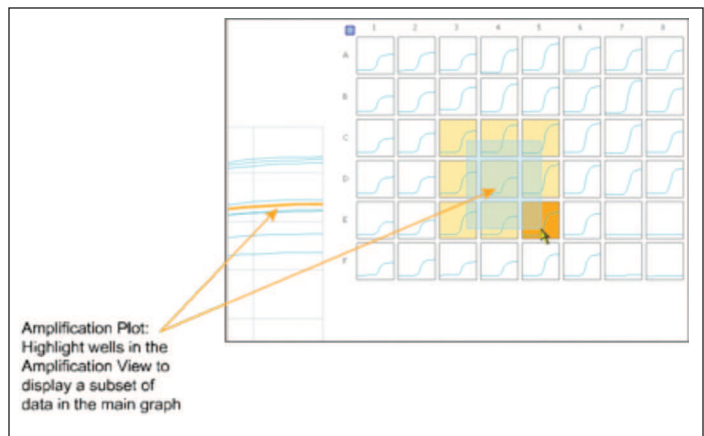

Figure 24 Amplification Plot

3. Workflow

- A Plate layout view shows sample type, sample identity, dilution and assays
- B Select by assay, sample or call using the drop-down arrow
- C Select the identity of the assay using the drop-down arrow
- D Turn Show Plate Layout on and off by selecting the box

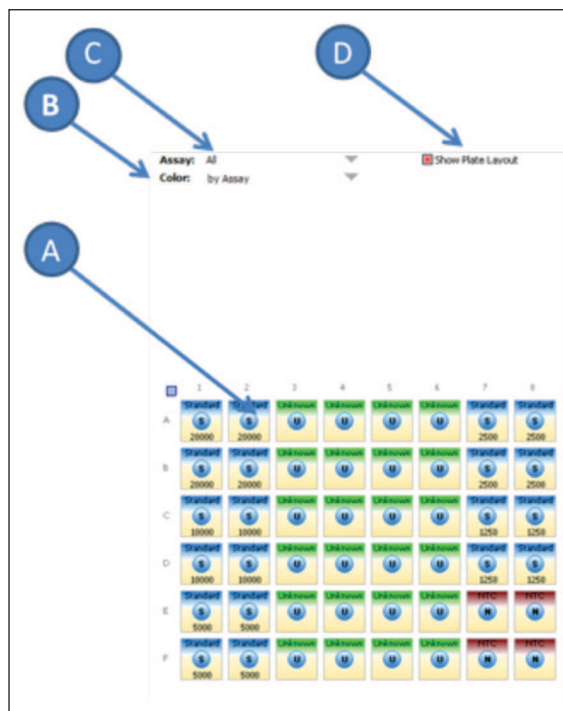

Figure 25 Plate Layout View in the Monitor Tab

3.18. EXPORT RESULTS AND DATA

Results, as well as other data, can be exported by selecting [File | Export](#) in the main menu. The options available here vary depending on the type of experiment you ran and the file format you chose to output. If a type of data is not available, it appears grayed out in the Export Options area. In the Export Options dialog box, select the desired file format and components to export, then click

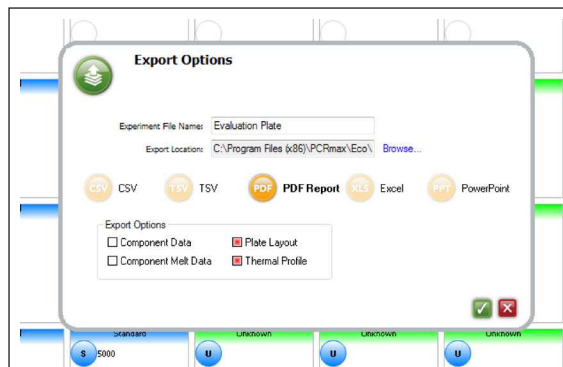

Figure 26 Export Options dialog box

3. Workflow

3.17. TEMPLATES AND SAMPLE SHEETS

The table below explains the differences between a template, a plate template, and a sample sheet. It also describes where and when templates and sample sheets can be saved, imported and exported. The commands below are available under the File menu in Eco 48. Only Import Plate Template and Export Plate Template are available in Eco 48 Study.

Command	Save a Template	Import a Sample Sheet	Import Plate Template	Export Plate Template
Description	A template is a layout and profile.	A sample sheet is a list of assays and samples, but unassigned to a layout.	A plate template is a plate layout, and does not include a thermal profile.	A plate template plate is a plate layout, thermal and does not include a thermal plate profile.
File Extension	*.ecot	*.csv	*.csv	*.csv
Where	Eco 48 Study	Eco 48 Eco 48 Study	Eco 48 or Eco 48 Study	Eco 48 or Eco 48 Study
When	Before a run	Before and after a run but not during a run	Before and after a run, but not during a run	Before and after a run, but not during a run
Notes	After saving, the template is available for use. It is listed in the Templates tab on startup in Eco 48.	See directions for Making a Sample Sheet for Import.	The Plate tab must be active.	

3. Workflow

3.18. MAKING A SAMPLE SHEET FOR IMPORT

To create your own sample sheet for import into Eco 48, use a program like Excel to create a *.csv file. The sample sheet can contain up to 99 assay names and 48 sample names.

- 1 In the same column, enter the heading "Assay Name" and "Sample Name".
- 2 Make sure there is a space between the assay list and the sample list.
- 3 Give each assay and sample a unique name.
- 4 Save the file as a *.csv file.

	A	B
1	Assay Name	
2	Assay 1	
3	Assay 2	
4	Assay 3	
5		
6	Sample Name	
7	Sample 1	
8	Sample 2	
9	Sample 3	
10		
11		

Figure 27 Example of a Sample Sheet

4. System Information

4.1.1. COMPONENTS

THERMAL SYSTEM

- Proprietary hollow silver thermal block filled with circulating conductive fluid provides superior temperature control and thermal uniformity across the sample plate
- Standard Fast protocol performs 40 PCR cycles in approximately 40 minutes

- A Motors
- B Stirring Paddles
- C Silver hollow Thermal Block, containing the conductive fluid

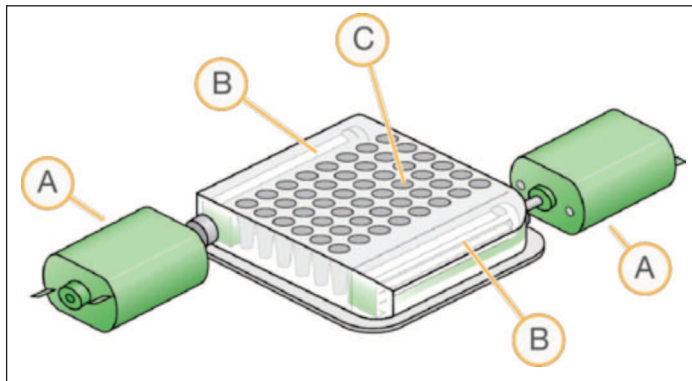

Figure 28 Eco 48 Thermal System

4.1.2 OPTICAL SYSTEM

- Two LED arrays provide individual sample well excitation
- Four detection filters support almost all PCR chemistries and multiplex detection (ROX™ is optional)
- CCD camera acquires high-quality data in all wells and filters at each PCR cycle

Factory-calibrated optics support SYBR™ Green, FAM™, HEX™, VIC™, ROX™, Cy5® and Q670™ dyes. You can also use other dyes that are compatible with the excitation and emission wavelengths.

- A CCD Camera
- B Filter Slide
- C Green LED Array
- D Blue LED Array

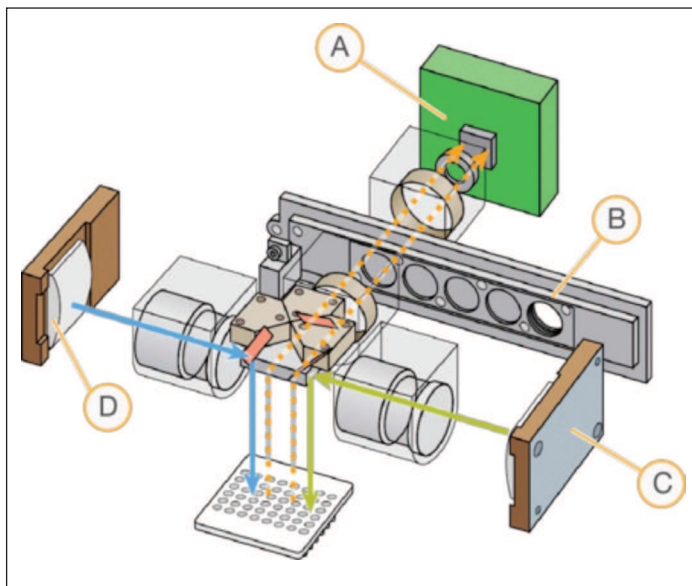
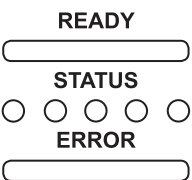
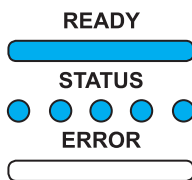
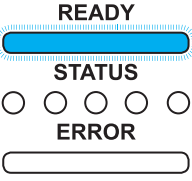
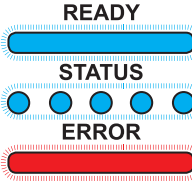
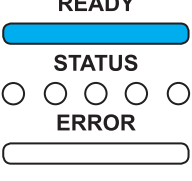
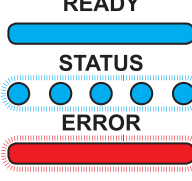
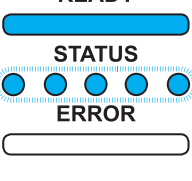
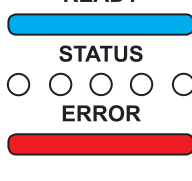
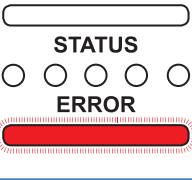
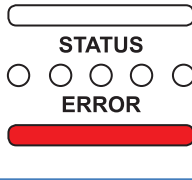
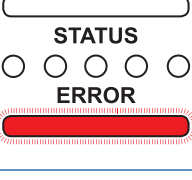
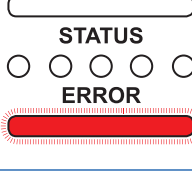
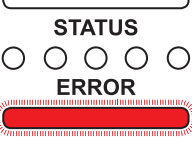
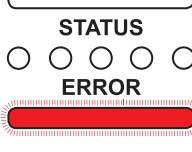

Figure 29 Eco 48 Thermal System

4. System Information

4.1.3. LIGHTS

The Eco 48 has three indicator lights on the front: **Ready**, **Status**, and **Error**. The following tables show the meaning of each combination of off, on, and flashing lights. If Power Cycling is advised for an error light, see Power Cycling on page 30.

Lights	Description	Lights	Description
<p>READY</p> 	Power on	<p>READY</p> 	Run Complete
<p>READY</p> 	Initializing (Conducting self tests and heating the thermal block).	<p>READY</p> 	Communication to PC error. Try power cycling the instrument to resolve
<p>READY</p> 	Ready/Idle	<p>READY</p> 	Software Updating
<p>READY</p> 	Run In Progress Do not switch off or open the lid while a run is in progress.	<p>READY</p> 	Non-Fatal Error Decide whether you want to terminate the run.
<p>READY</p> 	Fatal Error: Run Terminated Error light flashing. Instrument may have overheated or encountered a hardware failure.	<p>READY</p> 	Hardware Failure Solid Error light. Hardware problem. Call customer support.
<p>READY</p> 	Camera Initialization Error 2 long flashes of the Error light. Try power cycling the instrument to resolve.	<p>READY</p> 	Camera Trigger Error 3 long flashes of the Error light. Try power cycling the instrument to resolve.
<p>READY</p> 	Temperature Sensor Error 4 long flashes of the Error light. Hardware problem. Call customer support.	<p>READY</p> 	Temperature Response Error 5 long flashes of the Error light. Hardware problem. Call customer support.

4. System Information

4.2. MINIMUM SYSTEM REQUIREMENTS

Operating The following are the minimum requirements for running the Eco 48 software

- Operating system must be Windows 7, not starter, and in UK or USA English. Either 32 or 64 bit variant are compatible.
- Memory (RAM): 4GB DDR3
- Communication: Gigabit Ethernet and USB 2.0
- Processor: Core i3 (3rd generation) with at least 1.7 Ghz clock speed (ideally 2.4GHz clock speed).

Example PC: Dell Vostro 2420 or direct equivalent

The system should have all firewalls disabled as a precaution. Some firewalls disrupt communication between the PC and the Eco 48. The PC running the Eco hardware should be a designated unit with no 3rd party software on the system. Network ports being used by the Eco 48 should be set to not allow the operating system to shut down the port to save energy. Instructions for PC set up can be found on the Eco 48 quick start guide that shipped with the unit.













4.3. SPECIFICATIONS AND ENVIRONMENTAL REQUIREMENTS

Optical	Light Source	Two sets of 48 LEDs (452-486 nm and 542-582 nm)
	Detector	CCD camera (4 filters), (505-545 nm, 562- 596 nm, 604-644 nm, and 665-705 nm)
Thermal	Thermal Cycling	Proprietary hollow silver block with Peltier- based system
	Thermal Uniformity	± 0.1°C
Operational	Sample Format	48-well plate
	Reaction Volume	5–20 µl
	Warmup Time	~ 20 minutes
	Typical PCR Run Time	Less than 40 minutes for 40 cycles
	Sensitivity of Detection	1 copy
	High Resolution Melt	Supported resolution to 0.1°C
	Multiplexing	Detection of up to four targets simultaneously (four-plex)
Physical	Passive Reference	Optional (ROX)
	Dimensions	34.5 cm W x 31 cm D x 32 cm H (13.6 in. W x 12.2 in. D x 12.6 in. H)
	Weight	13.6 kg (30 lb) including power supply
Environmental	Electrical	100–240 VAC, 50-60 Hz, 5A
	Temperature Range	Operating: 15°C to 40°C (59° F to 104° F) Storage: 10°C to 100°C (50° F to 212° F)
	Humidity Range	Operating: 15–90% Relative Humidity Storage: 5–95% Relative Humidity
	Protection	IP20

4. System Information

4.4. SYMBOLS

The Eco 48 has three indicator lights on the front: Ready, Status, and Error. The following tables show the meaning of each combination of off, on, and flashing lights. If Power Cycling is advised for an error light, see Power Cycling on page 30.

Symbol	Description	Symbol	Description
	CAUTION: Hot Surface		Do Not Throw in Trash: At end of useful life, recycle the system or device
	European Representative		Fuse: replacement fuses must meet the stated rating
	Humidity Range (on packaging: indicates acceptable shipping and storage limits)		Manufactured By
	Mark of European Conformity: device complies with the EMC Directive (2004/108/EC) and the Low Voltage Directive (2006/95/EC)		Model Number
	Off		On
	Serial Number		Temperature Range (on packaging: indicates acceptable shipping and storage limits)

4. System Information

4.5. ELECTROMAGNETIC COMPATIBILITY

This equipment complies with the emission and immunity requirements described in IEC 61326-1:2005 and IEC 61326-2-6:2005. To confirm proper operation:

- The electromagnetic environment should be evaluated prior to operation of the system.
- Do not use this system in close proximity to sources of strong electromagnetic radiation (e.g. unshielded intentional RF sources), as these may interfere with proper operation.
- If you notice any interference, discontinue using the system until all issues are resolved. Resolution may include moving cords from other equipment away from the system, plugging the system into an outlet on a different circuit from other equipment, or moving the system away from the other equipment. If you continue to have difficulties, contact PCRmax.
- Eco 48 must be connected to reliable and suitable protective earth connection.

4.6. CLEANING AND MAINTENANCE

Clean the block and housing as needed, following these directions.

CAUTION If hazardous or biohazardous material is spilled onto or into the equipment, clean it immediately.

- 1 Turn the system off and allow the block to cool completely.
- 2 Using a lint-free cloth slightly dampened with clean water, gently wipe the surfaces of the equipment. If a stronger cleaning agent is needed, use a lint-free cloth slightly dampened with 95% isopropyl alcohol.

Follow these practices for proper maintenance of your Eco 48.

- Every time you use the system, visually check it to confirm there is no obvious physical damage such as dents, frayed cords, or damaged levers. If you see any damage, discontinue use and contact PCRmax Technical Support.
- Once a year, run a known test sample to confirm accurate analysis.

CAUTION The Eco 48 contains materials that may be hazardous to the environment if not disposed of properly. Be sure to dispose of materials according to all local, state/provincial, and national regulations.

5. Troubleshooting

5.1. INTRODUCTION

For most errors on the Eco 48, an on-screen message opens with instructions for correcting the error. Error lights on the front of the instrument may also indicate a problem and how to fix it. See Lights on page 26.

If connection is lost between the Eco 48 instrument and the computer, use the Run Recovery section to recover your run data. See Run Recovery on page 30.

This Troubleshooting section also has directions on how to access files and information that will help PCRmax Technical Support troubleshoot your problem. For instance, if you contact a PCRmax Technical Support representative, they might ask for copies of run-specific files for troubleshooting purposes, such as a log file. For technical questions, visit the Eco 48 support pages on the PCRmax website for access to frequently asked questions.

For problems with run quality or performance, contact PCRmax Technical Support. For more information, see Technical Assistance on page 36.

5.2. RUN RECOVERY

If the Eco 48 instrument loses connection with the computer, the Eco 48 often continues to run. After you reconnect your computer with the Eco 48, you can usually retrieve the run data because the data file of your last experiment is stored in the instrument. To recover the run data, follow the Power Cycling directions below to turn the computer and the Eco 48 off and on. After Power Cycling, select [Options | Recover Last Experiment](#) in the main menu.

5.3. POWER CYCLING

- 1 Turn off the power on the Eco 48. The power switch is on the back of the instrument.
- 2 Shut down the computer so that the power is off.
- 3 Wait three minutes.

NOTE Make sure that the Eco 48 and the computer are powered off for three minutes before you proceed to step 4.

- 4 Turn on the Eco 48 instrument.
- 5 Turn on the computer.
- 6 Double-click the Eco 48 icon on the computer desktop to start the Eco 48 software.
Communication between the computer and the Eco 48 instrument is established within five minutes.

NOTE If you are power cycling Eco 48 because the Eco 48 instrument and the computer lost connection, a warning message might appear during the connection time that says the experiment file may not have completed. The message asks you if you want the software to attempt to recover the run. Click Yes.

- 7 When [Status: Instrument Connected](#) displays at the bottom of the screen, the computer and the instrument are connected.
- 8 Wait until the Ready light on the Eco 48 instrument is solid blue. This takes up to twenty minutes.

5. Troubleshooting

5.4. RECOVER LAST EXPERIMENT

After you follow the directions for Power Cycling, you can recover the experiment that was running when the connection was lost between the Eco 48 Instrument and the computer.

- 1 Select [Options | Recover Last Experiment](#) in the main menu.
- 2 The name of your latest experiment with the word “recovered” appears in the [New Sessions](#) tab at the bottom of the screen.
- 3 To confirm that your data is recovered, go to the [Monitor Run](#) tab. If your data is recovered, you will see the data in the Amplification Plot and the Amplification View.
- 4 Select [File | Save As](#) to save your recovered data.

5.5. ACCESSING LOG FILES

Eco 48 stores a log file that helps with many troubleshooting issues. PCRmax Technical Support may ask for this file. To access the log file, follow the procedure here.

- 1 Turn on the Eco 48 and the computer.
- 2 Double-click the Eco 48 icon on the computer desktop to start the Eco 48 software. Communication between the computer and the Eco 48 instrument is established within five minutes. When [Status: Instrument Connected](#) displays at the bottom of the screen, the computer and the instrument are connected.
- 3 Close the Eco 48 software on the computer.
- 4 Navigate to [C:\ProgramFiles\pcrmax\Eco](#) and find the [GetLogs.exe](#) file. If you did not install the Eco program on the C drive, your drive letter may be different.
- 5 Open the [GetLogs.exe](#) file.
- 6 Select the [Include Previously Uploaded Logs](#) check box.
- 7 Click Get Log Files. When the file finishes transferring, Done appears on the GetLogs dialog box.
- 8 Save the zipped log file on your computer in an easy-to-remember place.
- 9 Email the zipped log file to PCRmax Technical Support at enquiries@pcrmax.com

5.6. IDENTIFYING SERIAL AND VERSION NUMBERS

To identify the Eco 48 instrument ID (serial) number, the software version number, and the instrument firmware version number, select [Help | About Eco 48/License Information](#) on the main menu.

6. Concepts and Glossary

6.1. CONCEPTS

The weight of one genome (g) = (size of genome in bp) x (618 g/mol/bp) x Avogadro's number

One human genome (g) = (3 x 10⁹ bp) x (618 g/mol/bp) x (6.02 x 10²³) = 3.08 x 10¹² g/mol

One haploid cell (sperm/egg) = 3.08 pg of DNA One diploid cell = 6.16 pg of DNA

There is approximately one copy of every non-repeated sequence per 3.08 pg of human DNA.

The average cell contains 10–20 pg of total RNA.

About 90–95% of total RNA is rRNA (18S, 5.8S and 28S). 1–3% is mRNA.

RNA concentration (µg/µl) = (A₂₆₀ * 40 * D)/1000, where D = dilution factor and A₂₆₀ = absorbance at 260 nm.

DNA concentration (µg/µl) = (A₂₆₀ * 50 * D)/1000, where D = dilution factor and A₂₆₀ = absorbance at 260 nm

The exponential amplification of PCR (X_n) is described by the following equation:

$$X_n = X_o * (1+E)^n$$

where X_n = number of target molecules at cycle n; X_o

= initial number of target molecules; E

= efficiency of target amplification; and n = number of cycles

Amplification efficiency (E) is described by the following equation: $E = 10^{(-1/\text{slope})} - 1$

The acceptable range of assay efficiency = 90% to 110%, or a slope between -3.1 and -3.6

A slope of -3.32 indicates 100% efficiency, meaning that the number of template molecules doubled in each PCR cycle.

Common reference genes:

- High expression: 18S ribosomal RNA (18S), Beta actin (ACTB), Beta-2-microglobulin (B2M), glyceraldehyde-3-phosphate dehydrogenase (GAPDH), and phosphoglycerokinase (PGK)
 - Medium expression: Transferrin receptor (TfR)
 - Low expression: Transcription factor IID TATA binding protein (TBP) and glucuronidase (GUS)
- Always validate your reference genes to ensure that the genes you select are stable in your experiments.

6. Concepts and Glossary

6.2. GLOSSARY

Term	Definition
Absolute Quantification	An assay that quantifies unknown samples by interpolating their quantities from a standard curve based on a serial dilution of a sample containing known concentration.
Allelic Discrimination	An assay that discriminates between two alleles (gene variants).
Amplicon	A fragment of DNA synthesized by a pair of primers during PCR.
Assay	The set of primers or primers/probe used to quantify an amplicon.
Baseline	The initial PCR cycles when little fluorescence signal is generated. This will be used to subtract the background.
Channel	The combination of excitation and emission spectra used to monitor amplification for a given assay.
Ct	Threshold Cycle. See Cq.
Cq	Quantification Cycle. The cycle number at which the fluorescent signal crosses the threshold. It is inversely correlated to the logarithm of the initial copy number.
Dark Quencher	A quencher without any native fluorescence. Black Hole Quencher (BHQ) dyes are an example.
Delta Rn (ΔR_n)	The normalized Fluorescence of an amplification plot with background and ROX normalization dye correction.
Derivate Melt Curve	A plot of temperature (x axis) versus the derivate of fluorescence with respect to temperature ($-dF/dT$) (y axis). Used to analyze the T_m of an amplicon.
DNA Binding Dye	A dye that increases its fluorescence in the presence of double-stranded DNA.
dsDNA	Double-stranded DNA.
Dual-Labeled Hydrolysis Probe	See hydrolysis probe.
Dynamic Range	The range of template concentration over which accurate Cq values can be determined. Extrapolation is not recommended.
Efficiency	See Slope.
Endogenous Control	An RNA or DNA template that is spiked into each sample at a known concentration.
End-Point Analysis	Qualitative analysis of PCR data at the end of PCR. Allelic discrimination assays (genotyping) are an example.
Exogenous Control	An RNA or DNA template that is spiked into each sample at a known concentration.
FAM (6-carboxy fluorescein)	The most commonly used reporter dye at the 5' end of a hydrolysis probe.
Filter	Components used to limit the bandwidth or the excitation or emission energy to the next component of the optical path.

6. Concepts and Glossary

6.2. GLOSSARY

Term	Definition
Fluorophore	The functional group of a molecule that absorbs energy at a specific wavelength and emits it back at a different wavelength.
Fluorescence	The immediate release of energy (a photon of light) as a result of an increase in the electronic state of a photon- containing molecule.
HEX	Carboxy-2',4,4',5',7,7'-hexachlorofluorescein.
High Resolution Melt (HRM)	An enhancement of the traditional melt curve analysis which increases the detail and information captured.
Hybridization Probe	A probe that is not hydrolyzed by Taq polymerase. Hybridization probes can be used for melt curve analysis. Examples include Roche FRET and Molecular Beacons
Fluorophore	The functional group of a molecule that absorbs energy at a specific wavelength and emits it back at a different wavelength.
Fluorescence	The immediate release of energy (a photon of light) as a result of an increase in the electronic state of a photon- containing molecule.
HEX	Carboxy-2',4,4',5',7,7'-hexachlorofluorescein.
High Resolution Melt (HRM)	An enhancement of the traditional melt curve analysis which increases the detail and information captured.
Hybridization Probe	A probe that is not hydrolyzed by Taq polymerase. Hybridization probes can be used for melt curve analysis. Examples include Roche FRET and Molecular Beacons.
Hydrolysis Probe	A probe that is hydrolyzed by the 5' endonuclease activity of Taq polymerase.
Internal Positive Control (IPC)	An exogenous control added to a multiplex qPCR assay to monitor the presence of inhibitors in the template.
JOE	Carboxy-4',5'-dichloro-2',7' dimethoxyfluorescein.
LED	Light Emitting Diode. A light that is illuminated by the movement of electrons in a semiconductor material. LED lights do not have filaments that burn out and do not get very hot.
Linear View	A view of an amplification plot using linear dRn values (y- axis) versus PCR cycles (x-axis).
Log view	A view of an amplification plot using log dRn values (y-axis) versus PCR cycles (x-axis).
LUX Primer Set	A self-quenched fluorogenic primer and a corresponding unlabeled primer. When the primer is incorporated into DNA during PCR the fluorophore is de-quenched, leading to an increase in fluorescent signal.
Melt Curve	See Derivative Melt Curve.

6. Concepts and Glossary

6.2. GLOSSARY

Term	Definition
Minor Groove Binders (MGBs)	dsDNA-binding agents typically attached to the 3' end of hydrolysis probes. MGBs increase the T_m value of probes, thus leading to smaller probes.
Molecular Beacons	Hairpin probes containing a sequence-specific loop region flanked by two inverted repeats. A quencher dye at one end of the molecule quenches the reported dye at the other end. Sequence-specific binding leads to hairpin unraveling and fluorescent signal generation.
Multiplexing	Simultaneous analysis of more than one template in the same reaction.
No Template Control (NTC)	An assay with all necessary components except the template.
Normalization	The use of control genes with a constant expression level to normalize the expression of other genes in templates of variable concentration and quality.
Passive Reference	A fluorescence dye such as ROX that the software uses as an internal reference to normalize the reporter signal during data analysis.
Peltier	Element used for heating and cooling in a qPCR machine.
Quencher	Molecule that absorbs fluorescence emission of a reporter dye when in close proximity. BHQ is a quencher.
R2 (Coefficient of Correlation)	The coefficient of correlation between measured C_q values and the DNA concentrations. It is a measure of how closely the plotted data points fit the standard curve. The closer to 1 the value, the better the fit. R2 is ideally > 0.99 .
Reference	A passive dye or active signal used to normalize experimental results.
Reference Genes	Genes with a wide and constant level of expression. Typically used to normalize the expression of other genes. Examples of commonly used reference genes: 16S/18S, GAPDH, and b-actin.
Relative Quantification	An assay used to measure the expression of a target gene in one sample relative to another sample and normalized to a reference gene.
Reporter Dye	Fluorescent dye used to monitor amplicon accumulation. This can be a dsDNA binding dye or a dye attached to a probe. Each dye is associated with a certain channel.
Rn (Normalized Reporter Signal)	Reporter fluorescent signal divided by fluorescence of the passive reference dye.
ROX (carboxy-X-rhodamine)	The most commonly used passive reference dye.
Slope	The slope of a standard curve. It is a measure of assay efficiency. $E = 10^{(-1/\text{slope})} - 1$, where a slope of -3.32 is equal to 100% efficiency (E) or an exact doubling of template molecules in each PCR cycle. Acceptable efficiencies range from -3.6 (90%) to -3.1 (110%). Overly high efficiencies indicate qPCR inhibition, usually due to contaminants in the sample. Overly low efficiencies typically indicate problems with the reaction mix concentration.

6. Concepts and Glossary

6.2. GLOSSARY

Term	Definition
Standard	A serial dilution of a target of known concentration used as template to generate a standard curve.
Standard Curve	A plot of C _q values against the log of target amount. Used to determine an assay's dynamic range, efficiency (slope), R ² , and sensitivity (y-intercept).
Standard Deviation (SD)	The SD of replicate C _q measurements is a measure of the precision of the assay.
TAMRA	Tetramethyl-6-carboxyrhodamine. Commonly used as a quencher.
Target	The DNA or RNA sequence to be amplified.
Template	See Target. Template can also refer to a saved experiment that can be used as a model for new experiments in the software.
Threshold	A level set above the background signal generated during the early cycles of qPCR. When adjusted manually, it should be set in the middle of the exponential stage of qPCR.
TET	Carboxy-2',4,7,7'-tetrachlorofluorescein.
T _m	The temperature at which 50% of dsDNA is single-stranded (melted).
Unknown	A sample containing an unknown amount of template.
Y-Intercept	In a standard curve, the value that crosses the y-axis at x = 1 (single copy target).

6.3. TECHNICAL ASSISTANCE

For technical assistance, go to www.pcrmax.com or contact your local dealer.

MSDSs

Material safety data sheets (MSDSs) are available on the PCRmax website at www.pcrmax.com.

Product Documentation

Product documentation, you can obtain PDFs from the PCRmax website, www.pcrmax.com

7. Declaration of Conformity

Declaration of Conformity

Real-time Thermal Cycler Models, PCRmax Eco 48

This product complies with the requirements of the EU Directives listed below:

2004/108/EC **EMC Directive.**
2006/95/EC **Low Voltage Directive (L.V.D)**

Compliance with the requirements of these Directives is claimed by meeting the following standards:

EN61326-1:2013 Emissions Class A and Immunity (Basic Requirements)

EN61010-1:2010 Safety requirements for electrical equipment for measurement, control, and laboratory use.
 General requirements

EN6101-2-010:2003 Safety requirements for electrical equipment for measurement, control, and laboratory use -
 Part 2-010: Particular requirements for laboratory equipment for the heating of materials

CE mark affixed 2014.

Other Standards

CFR47 Part 15: 2013 Radio Frequency devices (Subpart B) Class A

UL 61010-1:2012 Electrical Equipment For Measurement, Control, and Laboratory Use; Part 1: General Requirements

UL 61010A-2-010:2002 Electrical Equipment for Laboratory Use; Part 2: Particular Requirements for Laboratory Equipment for the Heating of Materials

CAN/CSA-C22.2 No. 61010-1:2012 Safety requirements for electrical equipment for measurement, control, and laboratory use - Part 1: General requirements

CAN/CSA-C22.2 No. 61010-2-010:2004 Safety Requirements for Electrical Equipment for Measurement, Control, and Laboratory Use - **Part 2-010:** Particular Requirements for Laboratory Equipment for the Heating of Materials

Signed:  (Mr S. Marriott)

Date: 3/10/14
 Technical Director
 Bibby Scientific Ltd



PCRmax Ltd - Stone - Staffs - ST15 0SA - UK
 Tel: +44 (0) 1785 812121 - Fax +44 (0) 1785 813748



PCRmax Limited

Beacon Road Stone
Staffordshire ST15 0SA
United Kingdom
Tel: +44 (0)1785 812121
Fax: +44 (0)1785 813748
e-mail: enquiries@pcrmax.com
www.pcrmax.com